

























Pellet stoves

Air, Multiair and Hydro.



DESCRIPTION	VERSION	CODE	PRICE
<p>EGO AIR</p>  <p>Pellet-burning stove with painted steel structure; firebox in Alutec®, cast iron grate, top in cast iron, sides in powder painted metal.</p> <p>Available thermal power 8 kW (Air) Available global thermal power 12.5 kW (Hydro) Thermal power to the water 10 kW (Hydro)</p>  	EGO Air	7109001	€ 1,650.00
	EGO Hydro	7109006	€ 2,550.00
	White	6909001	€ 140.00
	Dark	6909002	€ 140.00
	Silver	6909003	€ 140.00
	Burgundy	6909004	€ 140.00
	Fingerprint-proof stainless steel	6909005	€ 260.00
<p>STAR AIR</p>  <p>Pellet-burning stove with painted steel structure; firebox in Alutec®, grate in cast iron, top in cast iron, sides in ceramic/steatite.</p> <p>Available thermal power 8 kW (Air) Available global thermal power 12.5 kW (Hydro) Thermal power to the water 10 kW (Hydro)</p> 	STAR Air	7109001	€ 1,650.00
	STAR Hydro	7109006	€ 2,550.00
	Salt and pepper	6909006	€ 340.00
	Burgundy	6909007	€ 340.00
	Sienna	6909008	€ 340.00
	Soapstone-type	6909009	€ 520.00
<p>SUITE AIR</p> <p>SUITE COMFORT AIR</p>  <p>Pellet-burning stove with painted steel structure; firebox in Alutec®, cast iron grate, top, sides and front panel in ceramic.</p> <p>Available thermal power: 9.5 kW (Air) - 11.5 kW (Comfort Air) Available global thermal power 15.5 kW (Hydro) Thermal power to the water 13 kW (Hydro)</p> 	SUITE Air	7109002	€ 2,200.00
	SUITE Comfort Air	7109003	€ 2,530.00
	SUITE Hydro	7109007	€ 2,890.00
	Salt and pepper	6909010	€ 290.00
	Burgundy	6909011	€ 290.00
	Sienna	6909012	€ 290.00
<p>CLUB AIR</p> <p>CLUB COMFORT AIR</p>  <p>Pellet-burning stove with painted steel structure; firebox in Alutec®, cast iron grate, top, sides and front panel in ceramic.</p> <p>Available thermal power: 9.5 kW (Air) - 11.5 kW (Comfort Air) Available global thermal power 15.5 kW (Hydro) Thermal power to the water 13 kW (Hydro)</p> 	CLUB Air	7109002	€ 2,200.00
	CLUB Comfort Air	7109003	€ 2,530.00
	CLUB Hydro	7109007	€ 2,890.00
	White	6909013	€ 290.00
	Burgundy	6909014	€ 290.00
	Sand	6909015	€ 290.00
<p>MUSA AIR</p> <p>MUSA COMFORT AIR</p>  <p>Pellet-burning stove with painted steel structure; firebox in Alutec®, cast iron grate, top in cast iron, sides in powder painted metal.</p> <p>Available thermal power: 9.5 kW (Air) - 11.5 kW (Comfort Air) Available global thermal power 15.5 kW (Hydro) Thermal power to the water 13 kW (Hydro)</p> 	MUSA Air	7109004	€ 2,170.00
	MUSA Comfort Air	7109005	€ 2,500.00
	MUSA Hydro	7109008	€ 2,860.00
	White	6909016	€ 120.00
	Dark	6909017	€ 120.00
	Silver	6909018	€ 120.00
	Burgundy	6909019	€ 120.00
<p>ATHOS POWER HYDRO</p>  <p>Pellet-burning stove with painted steel structure; cast iron grate and back, black ceramic top and side coating made of powder-painted steel. A fan is available for hot air distribution in the room. HYDRO version: production of heating hot water and hot air (not ductable) HYDRO w/HEAT EXCHANGER: production of heating hot water, hot air (not ductable) and domestic hot water Available thermal power 23.7 kW Available thermal power yielded to the water 16.2 kW</p> 	Black	7109012	€ 3,650.00
	Silver	7109013	€ 3,650.00
	Burgundy	7109014	€ 3,650.00
	Black with exchanger	7109009	€ 3,990.00
	Silver with exchanger	7109010	€ 3,990.00
	Bordeaux with exchanger	7109011	€ 3,990.00







DESCRIPTION	VERSION	CODE	PRICE
<p>ATHOS MULTIAIR</p> <p>Pellet-fuelled stove with steel structure; fire box in Alutec®, grate in stainless steel, top in black ceramic and side cladding in powder painted steel.</p> <p>Available thermal power 11.5 kW</p> 	Silver sides	70233	€ 2,980.00
	Black sides	70232	€ 2,980.00
	Burgundy sides	70234	€ 2,980.00
<p>POLAR HYDRO  </p> <p>Pellet-burning stove with painted steel structure; cast iron grate and back, top, front panel and side coating in ceramic. A fan is available for hot air distribution in the room.</p> <p>HYDRO version: production of heating hot water and hot air (not ductable) HYDRO w/HEAT EXCHANGER: production of heating hot water, hot air (not ductable) and domestic hot water</p> <p>Available thermal power 23.7 kW Available thermal power yielded to the water 16.2 kW</p> 	HYDRO system	360051	€ 3,650.00
	HYDRO system with exchanger	360062	€ 3,990.00
	Burgundy ceramic kit (Hydro)	367123	€ 370.00
	Desert ceramic kit (Hydro)	367124	€ 370.00
<p>POLAR AIR/MULTIAIR  </p> <p>Pellet-burning stove with painted steel structure; fireplace in Alutec®, grate in stainless steel, top, front panel and ceramic side coating.</p> <p>Versions: AIR: hot air supply MULTIAIR: hot air ducted to other rooms</p> <p>Available thermal power 8.8 kW (Air) Available thermal power 11.5 kW (Multiair)</p> 	AIR system	360073	€ 2,620.00
	MULTIAIR system	360071	€ 2,920.00
	Burgundy ceramic kit (Air/M.air)	367115	€ 370.00
	Desert ceramic kit (Air/M.air)	367116	€ 370.00
<p>NOVA HYDRO  </p> <p>Pellet-burning stove with painted steel structure; cast iron grate and back, top, front panel and side coating in ceramic.</p> <p>HYDRO version: production of heating hot water and hot air (not ductable) HYDRO w/HEAT EXCHANGER: production of heating hot water, hot air (not ductable) and domestic hot water A fan is available for hot air distribution in the room.</p> <p>Available thermal power 23.7 kW Available thermal power yielded to the water 16.2 kW</p> 	HYDRO system	360051	€ 3,650.00
	HYDRO system with exchanger	360062	€ 3,990.00
	Black ceramic kit (Hydro)	367130	€ 370.00
	Burgundy ceramic kit (Hydro)	367128	€ 370.00
<p>NOVA AIR/MULTIAIR  </p> <p>Pellet-burning stove with painted steel structure; fireplace in Alutec®, grate in stainless steel, top, front panel and ceramic side coating.</p> <p>Versions: AIR: hot air supply MULTIAIR: hot air ducted to other rooms</p> <p>Available thermal power 8.8 kW (Air) Available thermal power 11.5 kW (Multiair)</p> 	AIR system	360073	€ 2,620.00
	MULTIAIR system	360071	€ 2,920.00
	Black ceramic kit	367118	€ 370.00
	Burgundy ceramic kit	367119	€ 370.00
<p>SOLAR</p> <p>Pellet-burning stove with painted steel structure; firebox in Alutec®, grate in stainless steel, top and cladding in ceramic.</p> <p>Available thermal power 8.7 kW</p> 	Structure	7108068	€ 2,430.00
	Burgundy Kit	367131	€ 540.00
	Italy red kit	367132	€ 580.00
	Salt and pepper kit	367133	€ 540.00
	Sand kit	367134	€ 540.00



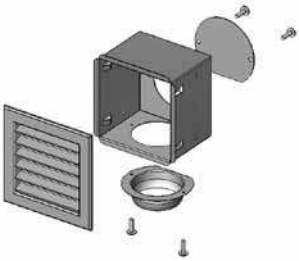

DESCRIPTION	VERSION	CODE	PRICE
<p>GEA</p> <p>Pellet-burning stove with painted steel structure; firebox in Alutec®, grate in stainless steel, top in black ceramic, sides in powder painted metal.</p> <p>Available thermal power 8.7 kW</p>  	<p>Black sides Burgundy sides Silver sides</p>	<p>7108215 7108216 7108217</p>	<p>€ 2,650.00 € 2,650.00 € 2,650.00</p>
<p>ANTARES</p> <p>Pellet-burning stove with painted steel structure; firebox in Alutec®, grate in stainless steel, top and side cladding in ceramic.</p> <p>Available thermal power 10.3 kW</p> <p>WHILE SUPPLIES LAST</p>  	<p>Structure</p> <p>Creamy white ceramic kit Burgundy ceramic kit Sea green ceramic kit Sand ceramic kit</p>	<p>360075 367030 367032 367084 367085</p>	<p>€ 3,580.00 € 490.00 € 490.00 € 490.00 € 490.00</p>
<p>AURORA</p> <p>Pellet-burning stove with painted steel structure; firebox in Alutec®, grate in stainless steel, top and side cladding in ceramic/steatite.</p> <p>Available thermal power 8.7 kW</p> <p>WHILE SUPPLIES LAST</p>  	<p>Structure</p> <p>White w/light blue edge ceramic kit White w/burgundy edge ceramic kit Burgundy ceramic kit Sea green ceramic kit Sand ceramic kit</p>	<p>360077 367056 367088 367055 367087 367091</p>	<p>€ 2,750.00 € 580.00 € 580.00 € 520.00 € 500.00 € 520.00</p>
<p>ASTRA</p> <p>Pellet-burning stove with painted steel structure; firebox in Alutec®, grate in stainless steel, top and side cladding in ceramic/steatite.</p> <p>Available thermal power 8.7 kW</p> <p>WHILE SUPPLIES LAST</p>  	<p>Str. for ceramic Str. for steatite</p> <p>Creamy white ceramic kit Yellow ceramic kit Burgundy ceramic kit Soapstone kit Sea green ceramic kit</p>	<p>360077 360089 367053 367054 367052 367064 367086</p>	<p>€ 2,750.00 € 2,600.00 € 520.00 € 520.00 € 520.00 € 1,130.00 € 520.00</p>
<p>VEGA</p> <p>Pellet-burning stove with painted steel structure; firebox in Alutec®, grate in stainless steel, top in black ceramic, sides in powder painted metal.</p> <p>Available thermal power 8.7 kW</p> <p>WHILE SUPPLIES LAST</p>  	<p>Black side Silver side Burgundy side</p>	<p>70223 70224 70225</p>	<p>€ 2,780.00 € 2,780.00 € 2,780.00</p>
<p>SATURN POWER</p> <p>Pellet-burning stove with painted steel structure; firebox in Alutec®, grate in stainless steel, top in ceramic, sides in powder painted metal.</p> <p>Available thermal power 8 kW</p>  	<p>Structure</p> <p>Black side kit Silver side kit Burgundy side kit</p>	<p>7108079 367140 367141 367139</p>	<p>€ 2,150.00 € 300.00 € 300.00 € 300.00</p>





DESCRIPTION	VERSION	CODE	PRICE
<p>OMEGA POWER</p> <p>Pellet-burning stove with painted steel structure; firebox in Alutec®, grate in stainless steel, top and cladding in ceramic.</p> <p>Available thermal power 8 kW</p> <p>WHILE SUPPLIES LAST</p>  		<p>Structure</p> <p>Burgundy Kit</p> <p>Desert kit</p> <p>Salt and pepper kit</p> <p>Sea blue kit</p>	<p>7108081 € 2,300.00</p> <p>367103 € 500.00</p> <p>367104 € 500.00</p> <p>367101 € 500.00</p> <p>367102 € 500.00</p>
<p>PLANET POWER</p> <p>Pellet-burning stove with painted steel structure; firebox in Alutec®, grate in stainless steel. Top, front and sides in ceramic.</p> <p>Available thermal power 8 kW</p> <p>WHILE SUPPLIES LAST</p> 		<p>Structure</p> <p>Burgundy Kit</p> <p>Desert kit</p> <p>Salt and pepper kit</p> <p>Sea blue kit</p>	<p>7108081 € 2,300.00</p> <p>367107 € 500.00</p> <p>367108 € 500.00</p> <p>367105 € 500.00</p> <p>367106 € 500.00</p>
<p>MERCURY POWER</p> <p>Pellet-burning stove with painted steel structure; firebox in Alutec®, grate in stainless steel, top in cast iron, sides in powder painted metal.</p> <p>Available thermal power 8 kW</p> <p>PelletBox</p>		<p>Black sides</p> <p>Burgundy sides</p> <p>Silver sides</p>	<p>7108220 € 1,920.00</p> <p>7108221 € 1,920.00</p> <p>7108222 € 1,920.00</p>







ACCESSORIES:
ducting for Suite, Club and Musa COMFORT AIR

<p>120x120 MULTI-DIRECTIONAL DIFFUSER</p> <p>Complete kit for air ducting up to 1.5 m. Kit composed of:</p> <ul style="list-style-type: none"> 1 120x120 multi-directional diffuser 1 frame 1 flange Ø 60 1 plug Ø 60 6 screws 1 90° wall union 1 flex pipe L = 1.5 m 4 clamps 1 fan/pipe connection Ø 60 		<p>4009012 € 56.00</p>
<p>FAN/PIPE CONNECTION Ø 60 mm</p> <p>Ducting connection with Ø 60 mm tube. Kit composed of:</p> <ul style="list-style-type: none"> 1 fan/pipe connection Ø 60 2 screws 1 clamp 		<p>4009007 € 14.00</p>

DESCRIPTION	VERSION	CODE	PRICE
<p>Ø 60 mm STRAIGHT CONNECTION</p> <p>Connection for duct connecting. Kit composed of: 1 straight connection 2 clamps</p> 		4009008	€ 3.50
<p>Ø 60 mm "Y" CONNECTION</p> <p>Connection to deflect the air flow to 2 ducts. Kit composed of: 1 "Y" connection 3 clamps</p> 		4009009	€ 9.50
<p>120x120 mm MULTI-DIRECTIONAL DIFFUSER</p> <p>Kit composed of: 1 120x120 multi-directional diffuser 1 frame 1 flange Ø 60 1 plug Ø 60 4 screws 1 clamp</p> 		4009010	€ 18.00
<p>Ø 60 mm 90° CONNECTION</p> <p>Kit composed of: 1 90° connection 3 clamps</p> 		4009011	€ 8.00
<p>FLEX PIPE Ø 60 L = 8 m</p> 		4009017	€ 32.00
<p>FLEX PIPE Ø 60 L = 1.5 m</p> 		4009003	€ 6.00

DESCRIPTION	VERSION	CODE	PRICE
<p>FAN/PIPE CONNECTION Ø 80 mm</p> <p>Ducting connection with Ø 80 mm tube. Kit composed of: 1 Ø 80 pipe/fan connection 2 screws 1 clamp</p> 		4009013	€ 8.00
<p>ACCESSORIES: ducting for Athos, Nova, Polar MULTIAIR</p> 			
<p>2-WAY FITTING</p> <p>From ø 10 cm to ø 8 cm for Polar and Nova stoves including flexible aluminium connection</p> 		40160344	€ 65.00
<p>SQUARE WHITE NOZZLE</p> <p>With closure and connector for Polar and Nova stoves</p> 	<p>Connector ø 8 cm</p> <p>Connector ø 10 cm</p>	<p>40160005</p> <p>40160006</p>	<p>€ 50.00</p> <p>€ 52.00</p>
<p>FLEXIBLE TUBE</p> <p>Flexible aluminium hose for channelling hot air. For stove Polar, Nova and Athos multiair.</p> 	<p>ø 8 cm</p> <p>ø 10 cm</p>	<p>40160052</p> <p>40160049</p>	<p>€ 8.50</p> <p>€ 14.00</p>

DESCRIPTION	VERSION	CODE	PRICE
<p>ACCESSORIES: generic for all pellet stoves</p>			
<p>REMOTE CONTROL For stove Ego and Star.</p> 		4009001	€ 40.00
<p>EXTERNAL THERMOSTAT INTERFACE Card for Ego and Star stoves to be inserted in the motherboard. It allows a remote thermostat to be used.</p> 		4009016	€ 10.00
<p>MODEM GSM modem system for Active System for remote connection via GSM cell phone.</p>  <p>GSM READY!</p>		40160428	€ 480.00
<p>FLOOR PROTECTION PLATE Available in anthracite colour painted metal or in tempered glass (photo) 90x100 cm (width x depth) Thickness of glass: 5 mm</p> 	<p>Anthracite painted metal</p> <p>Tempered glass</p>	<p>40140139</p> <p>40170147</p>	<p>€ 85.00</p> <p>€ 135.00</p>
<p>PAINT for touch-ups A - Black and grey silicon paint, 150 ml B - Water-based silicon spray paint - 200 ml Check on the unit the code to be used</p> 	<p>A - Black</p> <p>A - Grey</p> <p>B - Black</p> <p>B - Coal</p> <p>B - Micaceous grey</p>	<p>40180042</p> <p>40180041</p> <p>40180130</p> <p>40180043</p> <p>4009021</p>	<p>€ 15.00</p> <p>€ 15.00</p> <p>€ 15.00</p> <p>€ 15.00</p> <p>€ 15.00</p>

DESCRIPTION	VERSION	CODE	PRICE
STRAIGHT PELLET PIPE Painted pipe, 25 / 50 / 100 cm, with silicon gasket	L= 25 cm - ø 8 cm	40160463	€ 12.00
	L= 50 cm - ø 8 cm	40160464	€ 15.00
	L= 100 cm - ø 8 cm	40160465	€ 22.00
			
PELLET 90° CURVE Painted curve with silicon gasket	ø 8 cm	40160467	€ 21.00
			
PELLET 45° CURVE Painted curve with silicon gasket	ø 8 cm	40160468	€ 19.00
			
PELLET TEE UNION Condensation/ash collection painted tee union with silicon gasket	ø 8 cm	40160462	€ 29.00
			
PELLET WINDPROOF CAP Stainless steel windproof cap for wall discharge	ø 8 cm	40160156	€ 11.00
			
WALL FLANGE Painted wall flange	ø 8 cm	40160466	€ 7.00
			

DESCRIPTION	VERSION	CODE	PRICE
PELLET PIPE SUPPORT CLAMP Pipe support clamp for fastening to wall	ø 8 cm	40120968	€ 9.00
			
SILICON GASKET for pellet stove pipes 8 cm	pckg. of 5 pcs.	40120969	€ 10.00
